

Assembly instructions for the exhibition stand I102

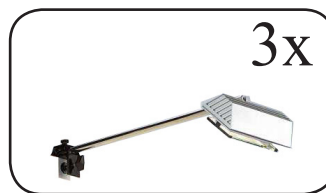

constisting of:

- 6x Aluminium profiles à 1250 mm incl. 8 bores
- 6x Aluminium profiles à 1250 mm incl. 8 bores and adjustable feet
- 2x Aluminium profiles à 300 mm incl. 8 bores for fascia sign frame
- 10x Aluminium cross profiles with pointed screws for the lower and upper mounting
- 5x Aluminium cross profiles for the middle mounting
- 6x Aluminium cross profiles with pointed screws for fascia sign frame
- 20x H-profiles à 1200mm to stabilize the panels.
- 6x Extension bolt for aluminium profile
- 3x Longarm spotlights 450mm incl. bulb

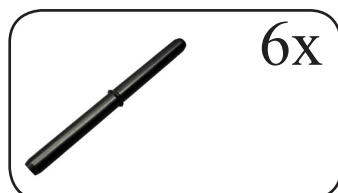
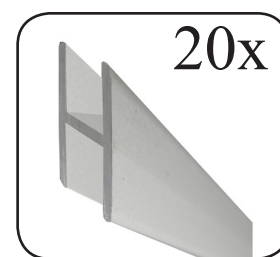
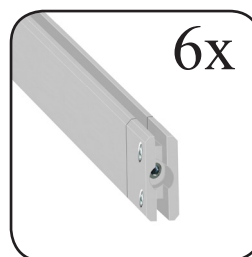
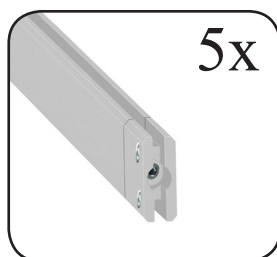
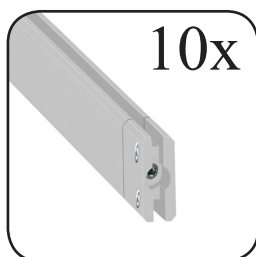
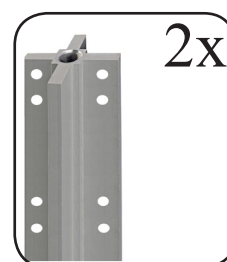
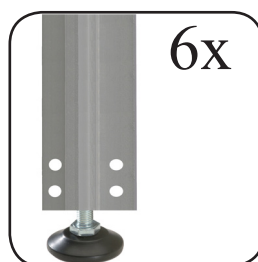
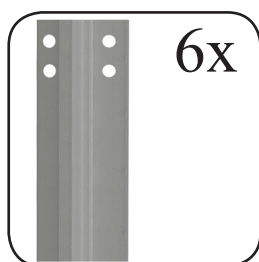

Important

Pointed screws must be used for all profiles with screw holes.

1. Mount the bottom cross profiles including the pointed screws to form the corner.

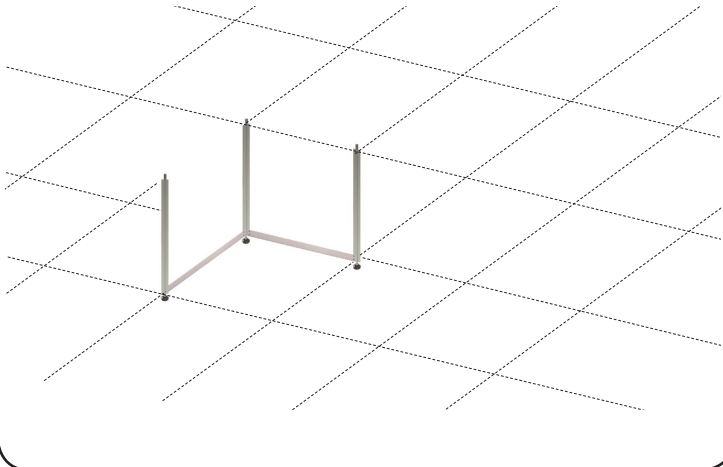

2. Then mount the cross profiles.

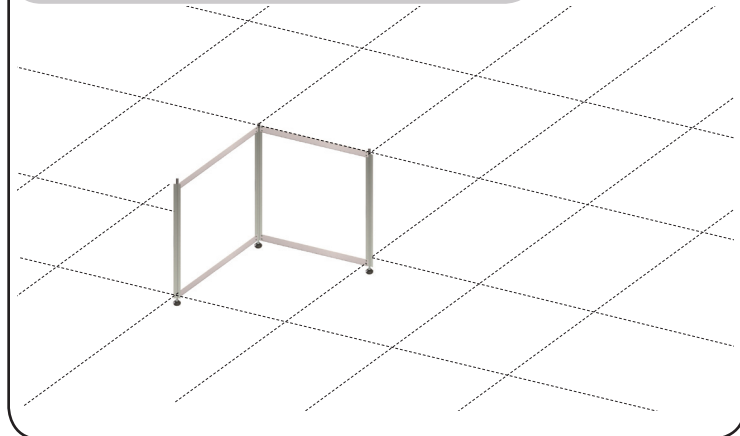

3. Mount the required lower cross profiles including pointed screws.

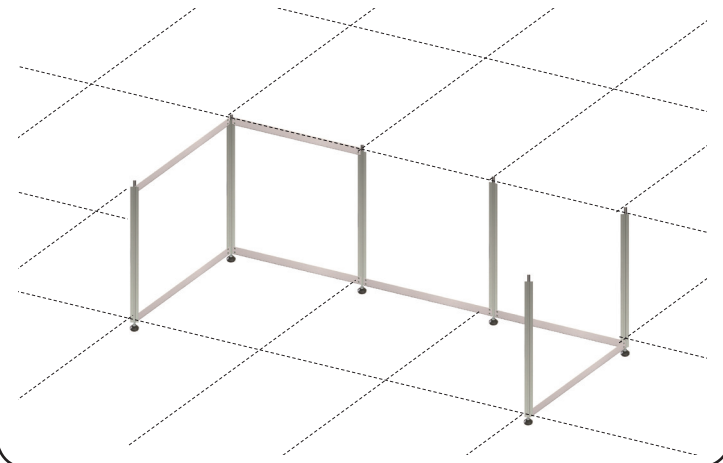

4. Then mount the cross profiles and insert the bolts in the profile.

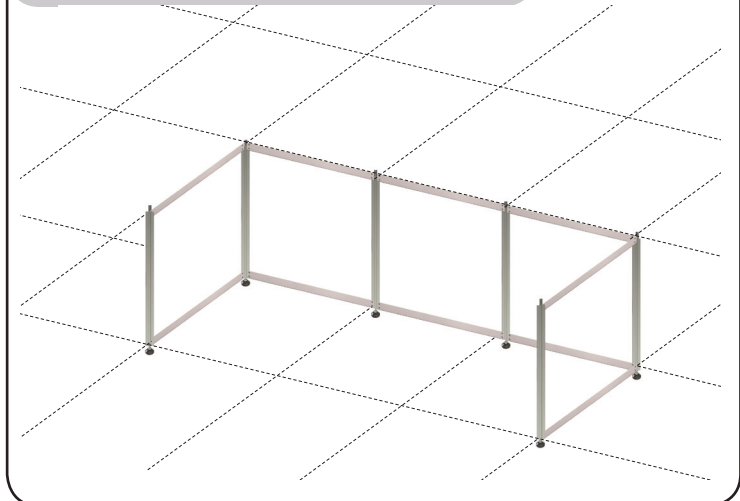

5. Push the top profiles onto the bolts. Ensure that the holes face upward.

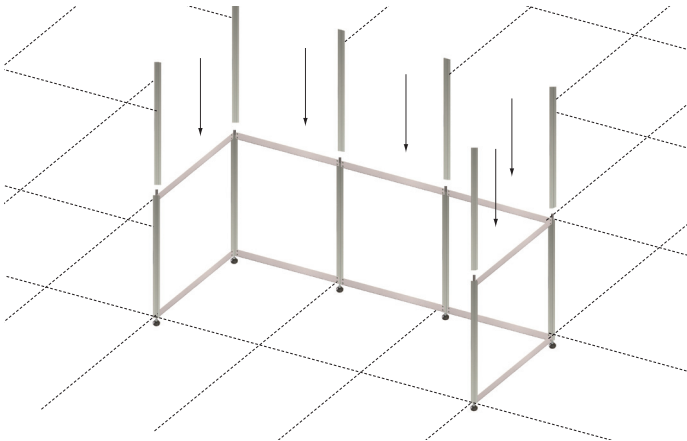

6. Then mount the cross profiles including the pointed screws.

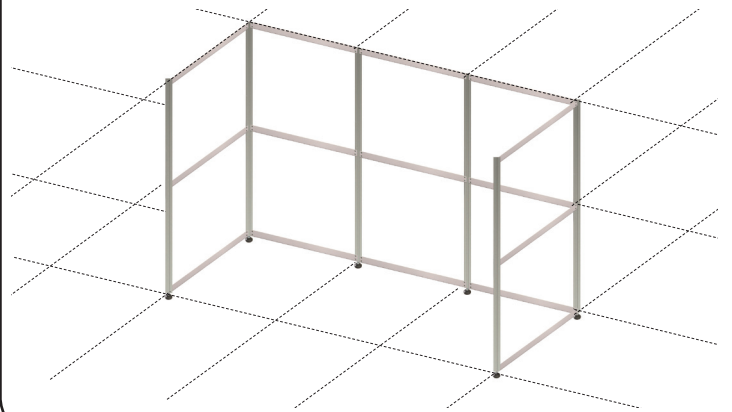

7. Then mount the fascia sign frame

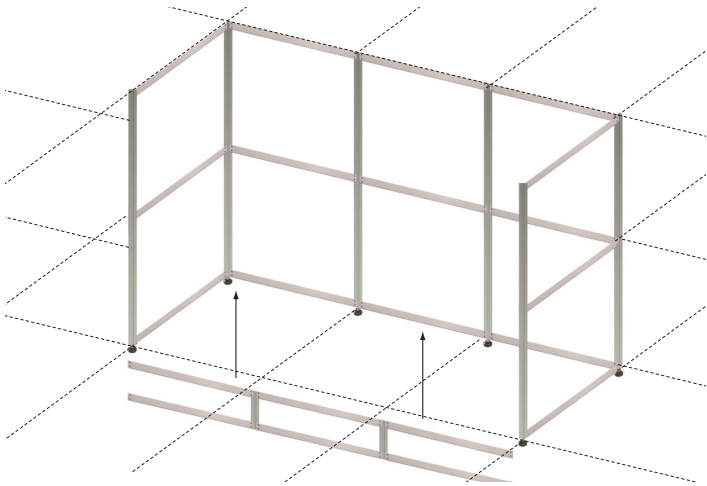

8. Fully assembled exhibition stand.
If necessary, use the adjustable feet to compensate for unevenness in the floor.

