

# Assembly instructions for the exhibition stand I121

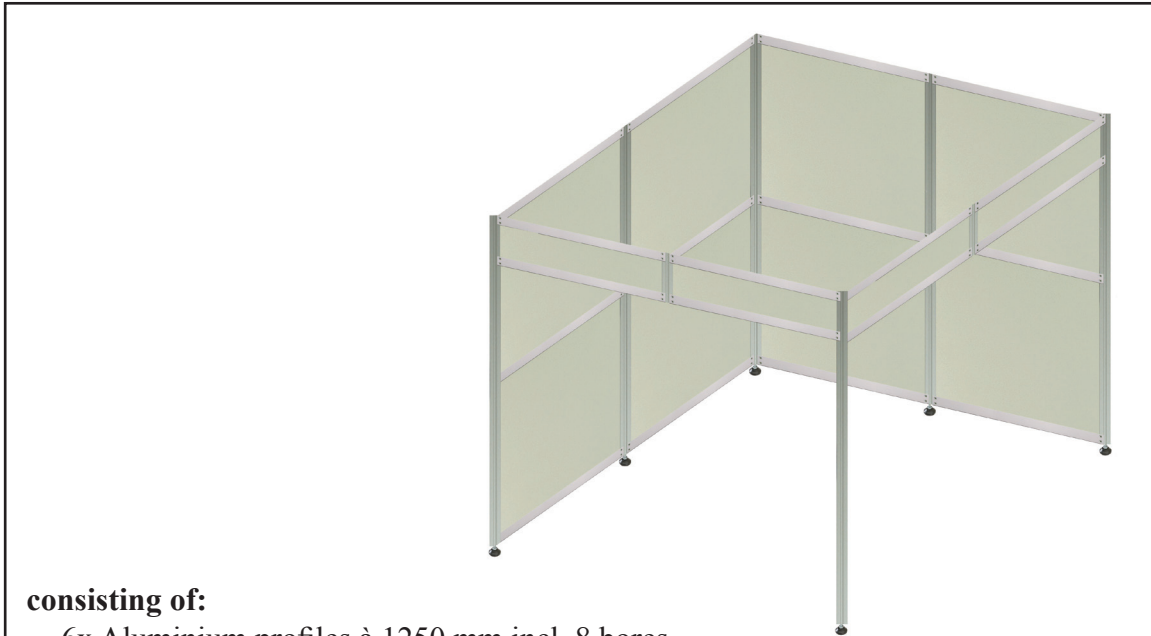

**consisting of:**

- 6x Aluminium profiles à 1250 mm incl. 8 bores
- 6x Aluminium profiles à 1250 mm incl. 8 bores and adjustable feet
- 2x Aluminium profiles à 300 mm incl. 8 bores for fascia sign frame
- 8x Aluminium cross profiles with pointed screws for the lower and upper mounting
- 4x Aluminium cross profiles for the middle mounting
- 8x Aluminium cross profiles with pointed screws for fascia sign frame
- 16x H-profiles à 1200 mm to stabilize the panels
- 6x Extension bolts for aluminium profile
- 8x PVC rigid foam panels à 952 x 1212 mm
- 4x PVC rigid foam panels à 952 x 246 mm
- 3x Longarm spotlights 450 mm incl. bulb

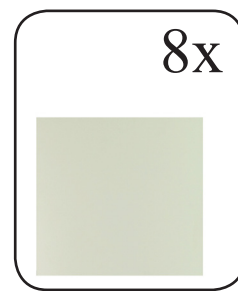
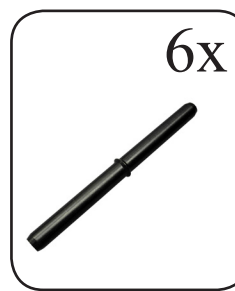
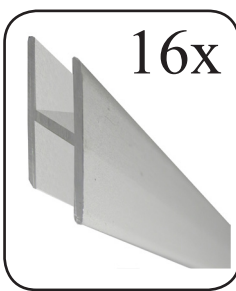
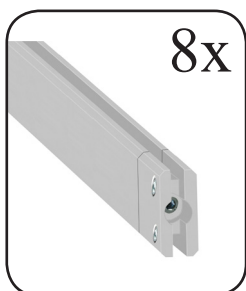
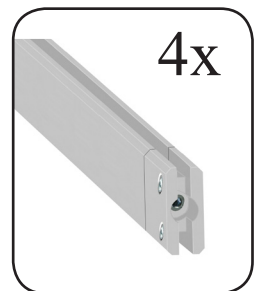
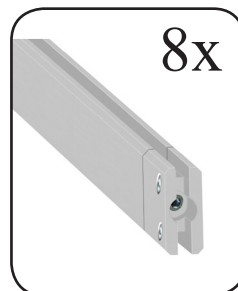
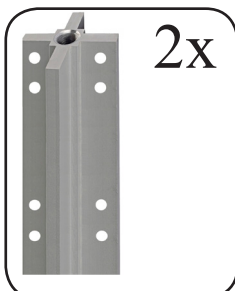
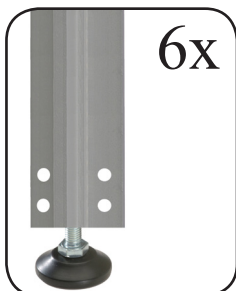
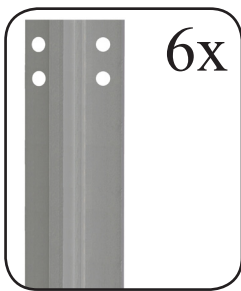

## Important

Pointed screws must be used for all profiles with screw holes.

1. Mount the bottom cross profiles including the pointed screws to form the corner.

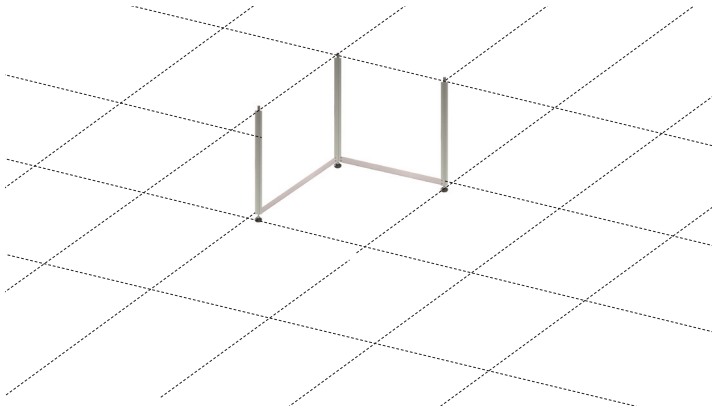

2. Insert the lower panels with the H-profiles and then mount the cross profiles.

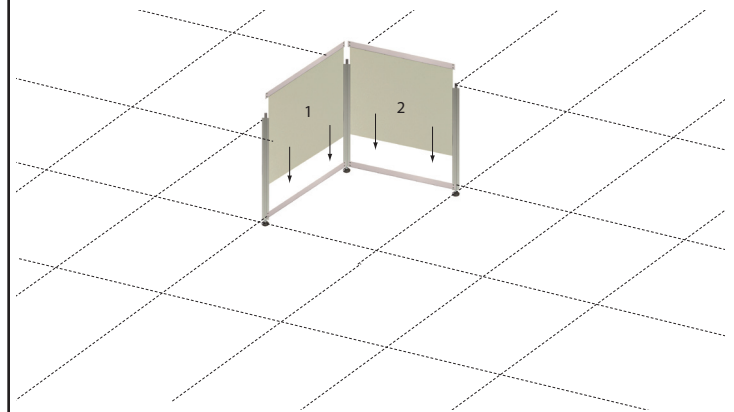

3. Mount the required lower cross profiles including pointed screws.

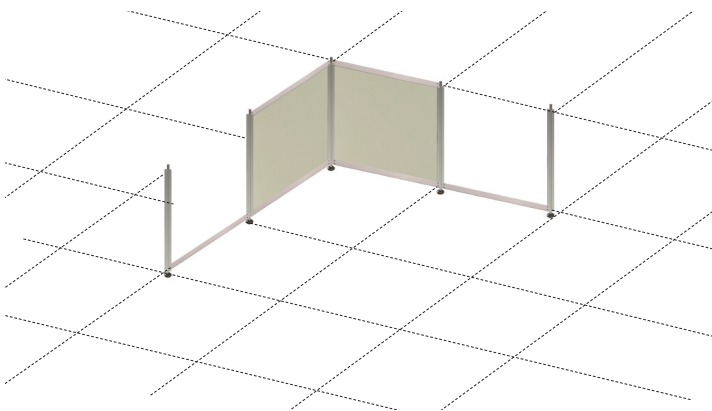

4. Insert the remaining panels with the H-profiles one after the other and then mount the cross profiles.

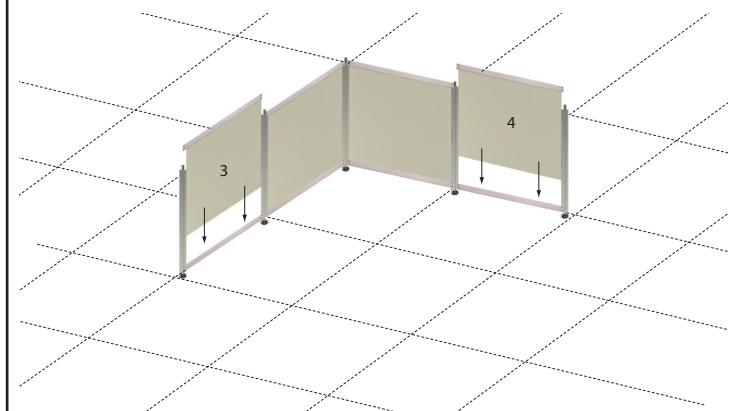

5. Insert the bolts in the profile.

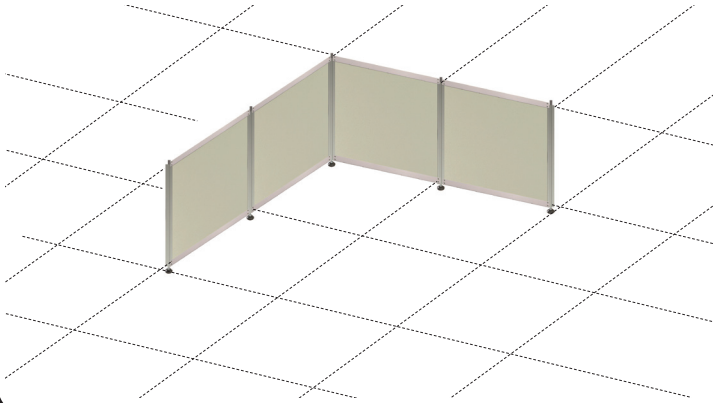

6. Push the top profiles onto the bolts.  
Ensure that the holes face upward.

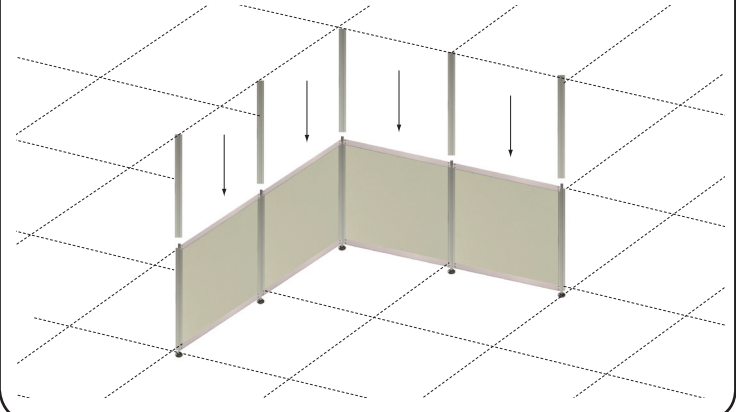

7. Insert the upper panels with the H-profiles one after the other and then mount the cross profiles including the pointed screws.

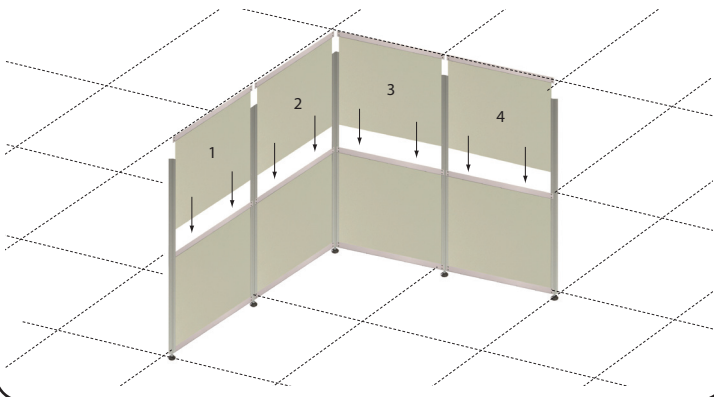

8. Then mount the first part of the fascia sign frame

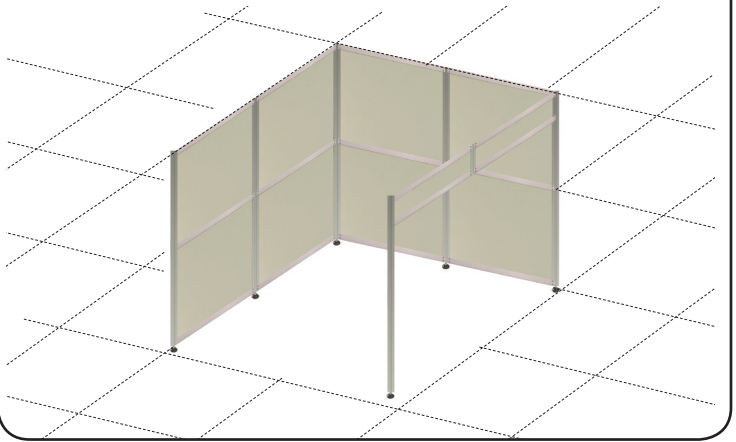

9. Then mount the rest of the fascia sign frame.  
If necessary, use the adjustable feet to compensate for unevenness in the floor.

