

Assembly instructions for the exhibition stand I105

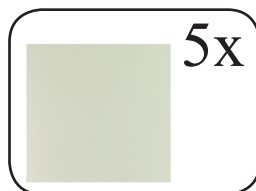
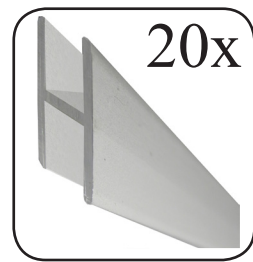
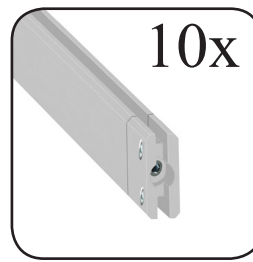
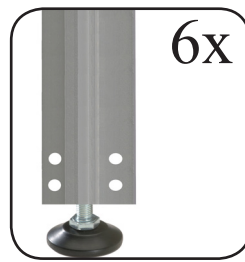
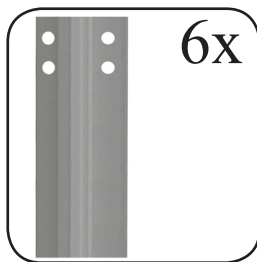
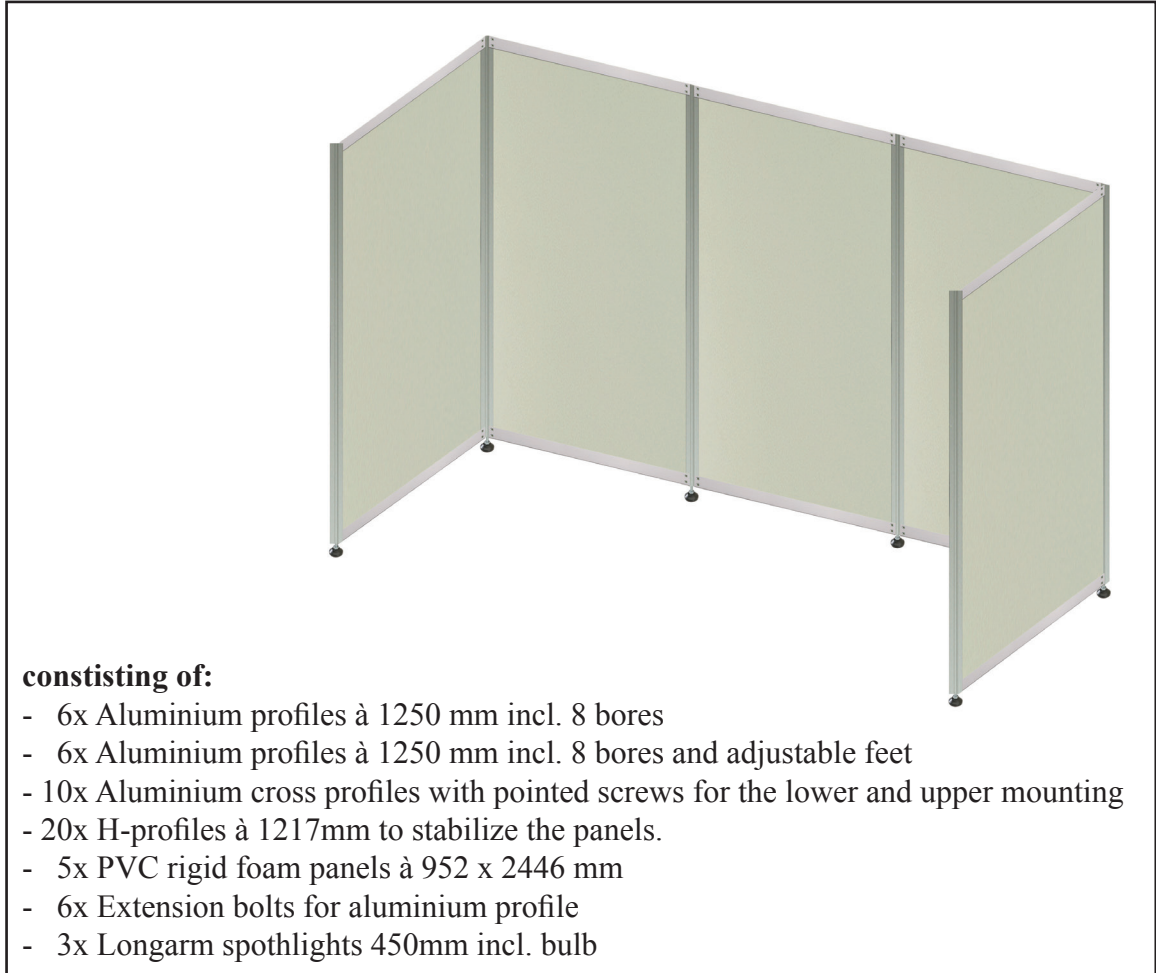

Important

Pointed screws must be used for all profiles with screw holes.

1. Mount the bottom cross profiles including the pointed screws to form the corner and insert the bolts in the profile.

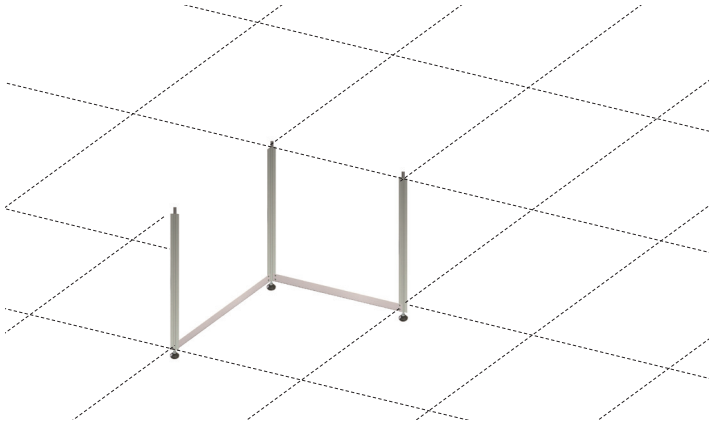

2. Push the top profiles onto the bolts. Ensure that the holes face upward.

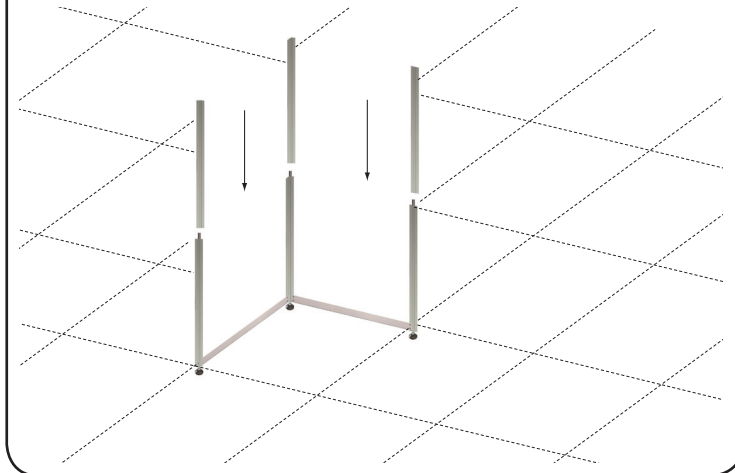

3. Insert the panels with the H-profiles and then mount the cross profiles including pointed screws.

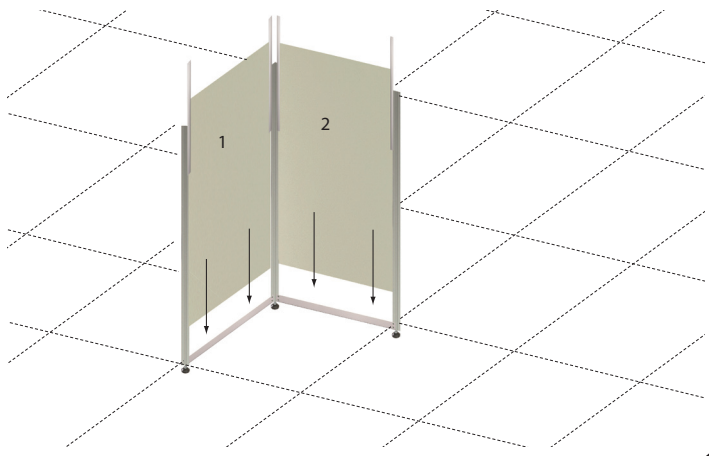

4. Mount the required lower cross profiles including pointed screws.

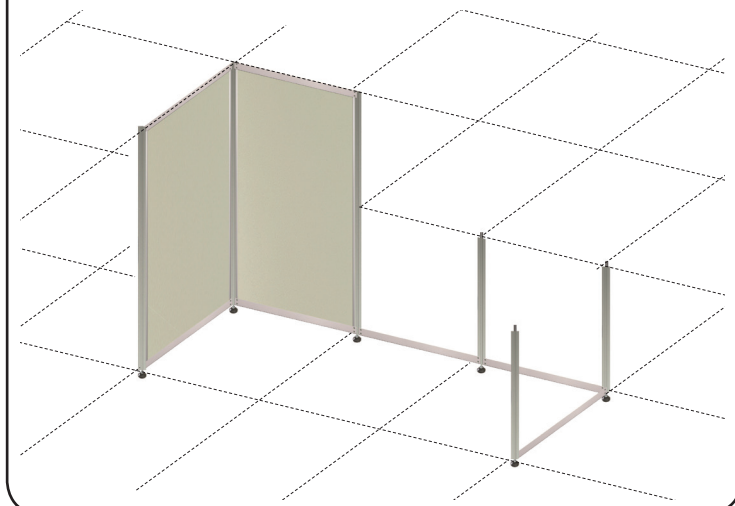

5. Insert the bolts in the profile and push the top profiles onto the bolts. Ensure that the holes face upward.

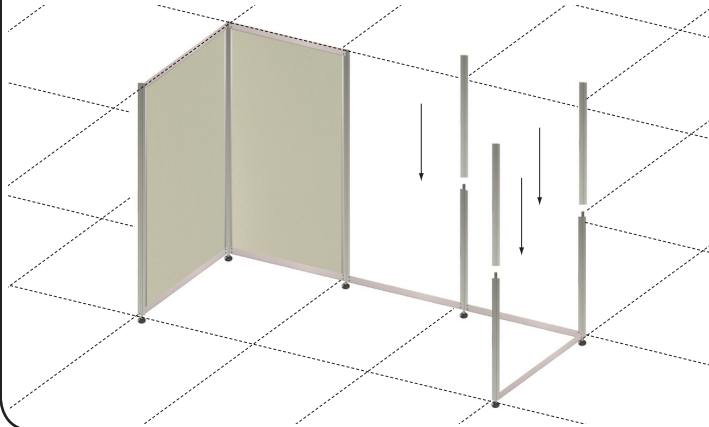

6. Insert the last panels with the H-profiles one after the other and then mount the cross profiles including the pointed screws.

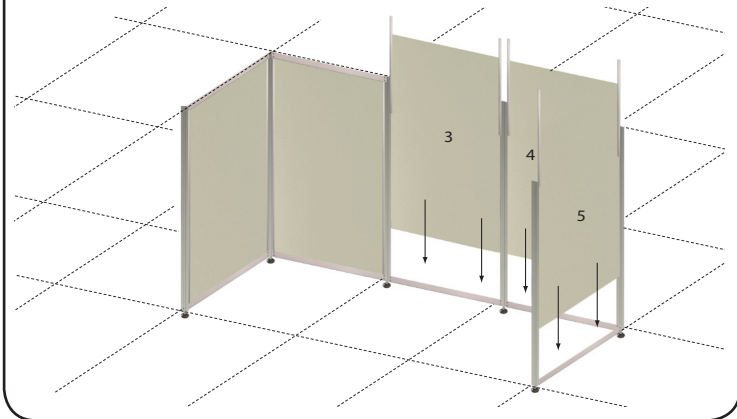

7. Fully assembled exhibition stand.
If necessary, use the adjustable feet to compensate for unevenness in the floor.

